

EC400S Portable Conductivity Meter Instruction Manual

PH400S Portable pH Meter



EC400S Portable Conductivity Meter



PC400S Portable pH/Conductivity Meter



APER A INSTRUMENTS (Europe) GmbH

www.aperainst.de

Table of Contents

1	Brief Introduction.....	- 3 -
2	Technical Specifications.....	- 4 -
2.1	Parameter Specifications.....	- 4 -
2.2	Other Specifications.....	- 5 -
3	Instrument Description.....	- 5 -
4	pH Measurement.....	- 8 -
4.1	Information regarding the pH Electrode.....	- 8 -
4.2	Information regarding pH Calibration.....	- 8 -
4.3	pH Calibration (Take 3-point calibration as an example).....	- 10 -
4.4	Sample Measurement.....	- 11 -
4.5	Maintenance of the pH Electrode.....	- 12 -
5	mV Measurement.....	- 13 -
5.1	ORP measurement.....	- 13 -
5.2	Notes on ORP measurement.....	- 13 -
6	Conductivity Measurement.....	- 14 -
6.1	Information regarding the Conductivity Electrode.....	- 14 -
6.2	Information regarding Conductivity Calibration.....	- 15 -
6.3	Conductivity Calibration.....	- 16 -
6.4	TDS, Salinity, Resistivity & Conductivity.....	- 17 -
6.5	Sample test.....	- 17 -
6.6	Maintenance of the Conductivity Electrode.....	- 18 -
7	Parameter Setting.....	- 18 -
7.1	Main Menu.....	- 18 -
7.2	Sub-Menu.....	- 18 -
7.3	pH Setting Sub-Menu.....	- 20 -
7.4	Conductivity Setting Sub-Menu.....	- 20 -
7.5	Basic Parameter Setting Sub-Menu.....	- 21 -
8	USB Data Communication.....	- 23 -
9	Complete Kit.....	- 24 -
10	Warranty.....	- 25 -
11	Appendix 1: Table of Parameter Setting and Factory Default Setting.....	- 25 -
12	Appendix 2: Icons and Abbreviation.....	- 26 -
13	Appendix 3: Table of Self-Diagnosis.....	- 27 -

1 BRIEF INTRODUCTION

Thank you for purchasing Apera Instruments EC400S Portable Conductivity Meters. Before using the product, please read this manual carefully to help you properly use and maintain the product. For technical support, please contact us at info@aperainst.de or +49 202 51988998

Apera Instruments reserves the right to update the content of this manual without giving prior notices.

1.1 Measuring Parameters

Measuring Parameters	PH400S	EC400S	PC400S
pH/mV	√		√
Conductivity/TDS//Salinity/Resistivity		√	√
Temperature	√	√	√

1.2 Features and Functions

- The built-in microprocessor chip enables advanced functions such as auto calibration, auto temperature compensation, auto electrode recognition, parameter setting, self-diagnosis, calibration reminder, calibration time check, auto power-off, low-battery reminder, etc.
- GLP data management, real-time clock display. Manual or Auto timing data storage. USB data communication.
- The meter adopts advanced digital processing technology, intelligently improves the response time and accuracy of the measurements. Stable reading and auto lock display mode are available for choice.
- Comes with a carrying case, which includes the meter, the electrode(s), calibration solutions, and other accessories, convenient for in-field use.
- Meets IP57 Waterproof and dustproof rating, ideal for use under harsh environment.

1.3 Features in pH Measurement

- 1 to 5 points auto calibration with calibration guide and auto-check function.
- Automatic recognition of calibration solutions. Two series of standard solutions for choice: USA and NIST

1.4 Features in Conductivity Measurement

- 1 to 4 points auto calibration with calibration guide and auto-check function.
- Single-tap switch among conductivity, TDS, salinity, and resistivity.
- Automatic recognition of conductivity calibration solutions.

2 TECHNICAL SPECIFICATIONS

2.1 Parameter Specifications

	Technical Parameters		Applicable Models
pH	Measuring Range	(-2.00 to 19.99) pH	PH400S PC400S
	Resolution	0.1/0.01 pH	
	Accuracy	±0.01 pH ±1 digit	
	Temperature Compensation Range	(0 to 100) °C, Automatic or Manual	
mV	Measuring Range	-1999 mV to 0 to 1999 mV	
	Resolution	1 mV	
	Accuracy	±0.1% F.S ±1 digit	
Conductivity	Measuring Range	Conductivity: 0 to 200 mS/cm, including 5 ranges: (0.00 to 19.99) µS/cm, (20.0 to 199.9) µS/cm, (200 to 1999) µS/cm, (2.00 to 19.99) mS/cm, (20.0 to 199.9) mS/cm TDS: (0 to 100) g/l, including 5 ranges: (0.00 to 9.99) mg/l, (10.0 to 99.9) mg/l, (100 to 999) mg/l, (1.00 to 9.99) g/l, (10.0 to 100.0) g/l Salinity: (0 to 100) ppt, Resistivity: (0 to 100) mΩ·cm	EC400S PC400S
	Resolution	0.01/0.1/1 µS/cm, 0.01/0.1 mS/cm	
	Accuracy	±1.0% F.S ±1 digit	
	Temperature Compensation Range	(0 to 50) °C, Automatic or Manual	
	Electrode Constant	0.1 / 1 / 10 cm ⁻¹	
Temperature	Measuring Range	-10 to 110°C	PH400S EC400S PC400S
	Resolution	0.1°C	
	Accuracy	±0.5°C±1 digit	

2.2 Other Specifications

Data Storage	PH400S, EC400S	500 Groups
	PC400S	1000 Groups
Storage Content	Numberings, Date, Time, Measurements, Unit, Temperature	
Data Output	USB	
Power Supply	AA Batteries *4 (1.5V*4)	
IP Rating	IP57 Waterproof and Dustproof	
Dimensions and Weight	PH400S, EC400S	Meter: (86x196x33) mm / 335 g. With case: (360x275x80) mm / 1,6 kg
	PC400S	Meter: (480x360x95) mm / 335 g With case: (480x360x95) mm / 4,2 kg

3 INSTRUMENT DESCRIPTION

3.1 LCD Display

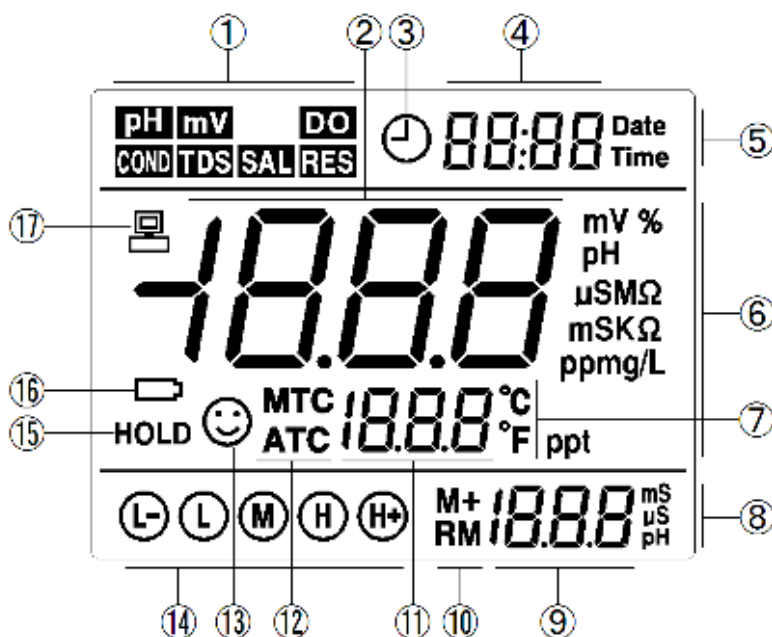

- ① — Measuring parameters
- ② — Measuring value
- ③ — Timing storage
- ④ — Date, time, and reminder icons
- ⑤ — "Date" and "Time"
- ⑥ — Measuring unit
- ⑦ — Temperature unit
- ⑧ — Measuring unit in calibration
- ⑨ — Calibration value, numberings of data storage, and reminder icons

- ⑩ — M+— Data storage; RM— Recall saved data
- ⑪ — Temperature and reminder icons
- ⑫ — ATC—Auto Temperature Compensation; MTC— Manual Temperature Compensation
- ⑬ — Stable reading icon
- ⑭ — Completed calibration icons
- ⑮ — Auto-Lock reading mode
- ⑯ — Low battery reminder. Please replace batteries when this icon is displayed.
- ⑰ — USB data communication. The meter is connected to your PC when this icon is displayed.

3.2 Keypad

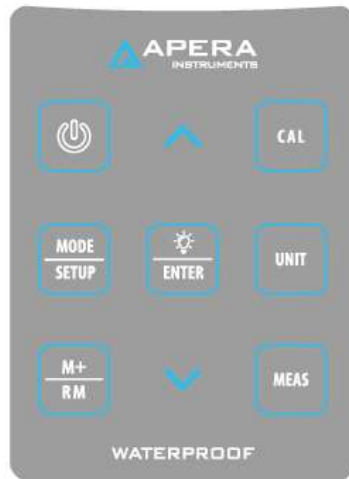



Figure-1

3.2.1 Short Press — <1.5 s; Long Press — >1.5 s .



3.2.2 Power On: Short press  to power on: LCD displays the measuring mode used last time (Backlight turned on for 1 minute).







3.2.3 Power Off: The meter can only be turned off in measuring mode by short pressing 

Special Notes: Pressing  in calibration mode or parameter setting mode will NOT turn the meter off.

Users need to press  first to go back to measuring mode, and then press  to power off.

Table- 1 Keypad Operation and Functions

Keypad	Operation	Functions
	Short Press	<ul style="list-style-type: none"> • Power on/off
	Short Press	<ul style="list-style-type: none"> • Choose measuring mode: • PH400S pH Meter: pH → mV • PC400S pH/Cond. Meter: pH → mV → COND • EC400S Cond. Meter: N/A
	Long Press	<ul style="list-style-type: none"> • Enter parameter setting



	Short Press	<ul style="list-style-type: none"> Enter calibration mode
	Short Press	<ul style="list-style-type: none"> In pH mode: choose resolution 0.01 pH→0.1 pH In conductivity mode: choose: COND → TDS → SAL → RES
	Short Press	<ul style="list-style-type: none"> In measurement mode: press to turn on/off the backlight In calibration mode: press to calibrate In parameter setting mode: press to confirm choice
	Short Press	<ul style="list-style-type: none"> Cancel any operation, the meter goes back to measurement mode
	Short Press	<ul style="list-style-type: none"> Save measuring data
	Long Press	<ul style="list-style-type: none"> Recall saved measuring data
	Short Press or Long Press	<ul style="list-style-type: none"> In manual temperature compensation (MTC) mode: Short press to adjust temperature, long press to adjust swiftly. In parameter setting mode: press to change the numbering of parameters in main menu and sub-menu. In sub-menu, press to change parameters and settings. In recall mode (RM), short press to change numberings, long press to change swiftly.

3.3 Connectors

The meter adopts 8-pin connector, into which pH, ORP, and conductivity electrode can be connected. When connected, the meter will automatically switch to the correspondent measurement mode.

3.4 Display Mode

3.4.1 Stable Reading Display Mode

When the measuring value is stable, the screen displays  as shown in figure-2. If  does not appear or is flashing, that means the measuring value has not been stable. Users should wait for the smiley face and not record the readings or conduct calibrations at that moment.

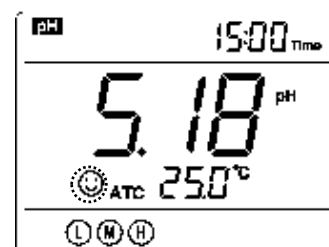



Figure-2

3.4.2 Auto-Lock Display Mode

In parameter setting P4.6, select “On” to turn on the auto-lock display mode, in which the reading will be automatically locked after the measuring value has been stable for more than 10 seconds, and the HOLD icon will come up as shown in figure-3. Short press  to cancel the hold.

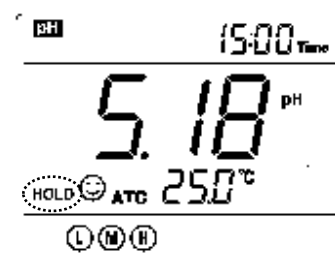



Figure-3

3.5 Data Storage, Recall, and Deletion

3.5.1 Manual Data Storage

When reading is stable, short press , the screen will display M+ icon along with the storage numbering, and the data will be saved, as shown in figure-4. For the storage capacity for each model, please refer to section 2.2

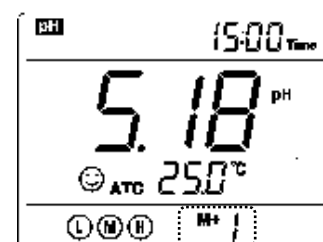







Figure-4

3.5.2 Automatic Timing Data Storage

In parameter setting P4.1, set up the time for timing measurements (e.g.

3 minutes).  will be displayed, meaning the meter is ready to enter the auto timing storage mode. Short press , the  icon will start flashing, and the 1st group of data will be stored. 3 minutes later, the 2nd one will be stored. Figure-5 shows that 8 groups of data have been automatically

stored. Short press  again, the  icon will stop flashing. The meter stops the auto timing storage. When in auto timing storage, manual storage is disabled. In parameter setting P4.1, set the time to 0 to exit auto timing storage.

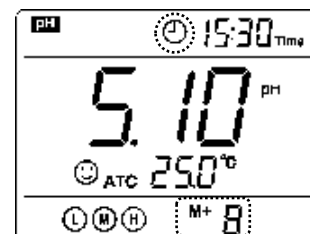







Figure-5

3.5.3 Recall the Stored Data

In measurement mode, long press , the meter will recall the measured value that was lastly saved, as shown in figure-6, displaying RM icon and the numbering.

Press  or  to recall other stored data. Long press  or  to change numberings swiftly.

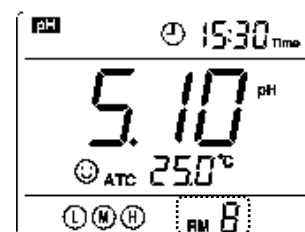

Figure-6

3.5.4 Clear Stored Data

In parameter P4.5, select Yes to clear all the stored data. For details, please refer to section 7.5

4 pH MEASUREMENT

4.1 Information regarding the pH Electrode

The instrument is equipped with a 201T-S 3-in-1 Combination pH Electrode. Its built-in temperature sensor allows for auto temperature compensation. The electrode's housing adopts PC plastics, which is shock-resistant and corrosion-resistant. When the pH electrode is dipped into the test sample solution, stir it for a few seconds to remove potential air bubbles inside the probe to help the measurement get stabilized quickly.

When connecting the electrode into the instrument, please slowly rotate the connector, identify the location of the mount to insert it, and then screw it on. Please note that do not pull on the cables in case of poor contact.





Please keep the connector clean and dry. For detailed maintenance of the electrodes, please refer to section 4.5

4.2 Information regarding pH Calibration

4.2.1 Standard Buffer Solutions

The instrument adopts two series of standard buffer solutions: USA and NIST as shown in Table-2. Users can select which one to use in P1.1 (refer to section 7.3).

Table-2

Calibration Icons		pH Standard Buffer Series	
		USA Series	NIST Series
5 Points Calibration		1.68 pH	1.68 pH
		4.00 pH	4.01 pH
		7.00 pH	6.86 pH
		10.01 pH	9.18 pH
		12.45 pH	12.46 pH
	3 Points Calibration		





4.2.2 pH Calibration Modes

The instrument has two calibration modes for choice: 3-point calibration (3P) and 5-point calibration mode (5P). Users can make the selection in parameter settings P1.4 (refer to section 7.3)

a) 3-point Calibration Mode

The 3-point calibration mode is the most commonly used. Users can adopt 1 to 3 points to calibrate as needed. In the 3-point calibration mode, the 1st point must be 7.00 pH (or 6.86 if using NIST). Then choose other calibration solutions to conduct 2nd and 3rd points (see Table-3 for details). In the process of calibration, the meter will display the electrode's slope in acid and alkaline ranges.

Table-3 3-point Calibration Mode

	USA	NIS	Calibration icon	When to adopt
1-Point Calibration	7.00 pH	6.86 pH		accuracy ≤ ±0.1 pH
2-Point Calibration	7.00 pH and 4.00/1.68 pH	6.86 pH and 4.01/1.68 pH		Measuring range: 0 to 7.00 pH
	7.00 pH and 10.01 pH	6.86 pH and 9.18 pH		Measuring range: >7.00 pH
3-Point Calibration	7.00pH, 4.00/1.68 pH and 10.01 pH	6.86pH, 4.01/1.68pH, 9.18 pH		Wide measuring range

b) 5-point Calibration Mode

In 5-point calibration mode, users can adopt 1 to 5 points of calibration, and can choose calibration buffer solutions at any sequence. Typically, 5-point calibration is recommended when testing strong acid or strong base solutions.

4.2.3 How often to calibrate

The frequency that you need to calibrate your meter depends on the tested samples, condition of electrodes, and the requirement of the accuracy. For High-Accuracy measurements ($\leq \pm 0.02\text{pH}$), the meter should be calibrated before test every time; For ordinary-accuracy Measurements ($\geq \pm 0.1\text{pH}$), once calibrated, the meter can be used for about a week or longer. In the following cases, the meter must be re-calibrated:

- The electrode hasn't been used for a long time or the electrode is brand new.
- After measuring strong acid ($\text{pH} < 2$) or strong base ($\text{pH} > 12$) solutions.
- After measuring fluoride-containing solution and strong organic solution
- There is a big difference between the temperature of the test sample and the temperature of the buffer solution that is used in the last calibration.

4.2.4 Calibration Reminder Function

Preset the interval between calibrations (starting from the time when you set it), and then the meter will remind you to calibrate at the end of that interval. For details, please see P1.2 (Section 7.3). When the preset time is reached, **Er6** icon will be displayed at the lower right corner of the LCD (as showed in Figure-8). At the time, the meter can still be operated. It is just reminding you to do calibration in order to ensure the accuracy. After calibration, the **Er6** icon will disappear; To make it disappear, users can also choose "No" in P1.2 in parameter setting.



4.2.5 Check calibration date



In this mode, users can see the date and time of last calibration to help determine if there is a need to re-calibrate. For details, please see parameter setting P1.3 (Section 7.3)

4.3 pH Calibration (Take 3-point calibration as an example)

4.3.1 Press  to enter calibration mode. CAL1 icon will flash in the upper right corner of the LCD. 7.00 pH will flash in the lower right corner of the LCD, reminding you to use pH 7.00 buffer to conduct 1st point of calibration.

4.3.2 Use distilled water to rinse off electrode and then dry it. Dip it into pH 7.00 buffer solution, stir gently and let it stand still and wait for the reading to become stable. In the lower right corner of LCD, the process of auto recognizing the buffer solution will be displayed. Pressing  before the buffer is recognized will generate Er2 (please refer to table 6).

4.3.3 When the meter locks 7.00 pH,  displays on LCD. Press  key to calibrate the meter. **End** icon appears after calibration is done. The 1st point calibration is finished. In the meanwhile, CAL2 will flash at the upper right corner, and 4.00 pH & 10.01 pH will flash alternately at the bottom right, indicating using pH 4.00 or pH 10.01 buffer solution to make the 2nd point calibration.

4.3.4 Take out pH electrode, rinse it in distilled water, dry it, and dip it into pH 4.00 buffer solution. Stir the solution gently and let stand still in the buffer solution until a stable reading is reached. The meter's display will show the recognition process of calibration buffer solution at the lower right of LCD. When the meter recognizes 4.00 pH,  displays on LCD. Press  key to calibrate the meter. End icon and electrode slope of acidity range display after calibration is done. In the meanwhile, CL3 will flash at the upper right corner of the LCD, and 10.01 pH will flash at the lower right, indicating using pH10.01 buffer solution to make the 3rd point calibration.

4.3.5 Take out pH electrode, rinse it in distilled water, dry it, and dip it into pH 10.01 buffer solution. Stir the solution gently and let it stand still in the buffer solution until a stable reading is reached. The meter's display will show recognition process of calibration buffer solution at the bottom right of LCD. When the meter recognizes 10.01 pH,  displays on LCD.

Press  key to calibrate the meter. End icon and electrode slope of alkalinity range display after calibration is done. The meter returns to the measurement mode, displays stable measuring value and calibration guide icons. Please see Figure-8 for the above calibration process.

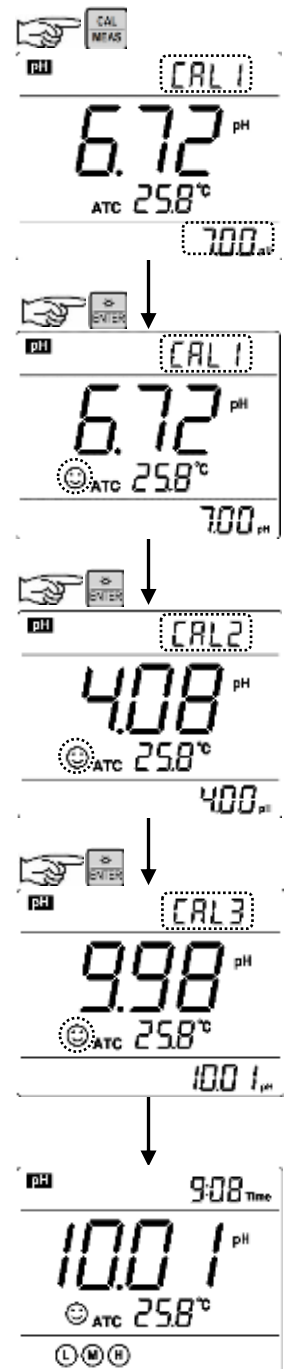



Figure-8

4.3.6 5-point calibration has the same process as the above shows. Users can choose calibration solutions without any sequence, and the slope data will not be displayed. During the calibration process, press  key to exit from the calibration mode. Correspondent calibration guide icons will appear on the LCD.

4.4 Sample Measurement

4.4.1 Rinse the pH electrode in distilled water or pure water, dry it, and dip it into sample solution. Stir the solution gently and let it stand still in the sample solution until ☺ icon appears and stays on LCD, get the pH reading, which is pH value of sample solution, please refer to Figure-9 for calibration and measurement process of the pH meter.

Figure-9 Calibration and measurement process of pH meter

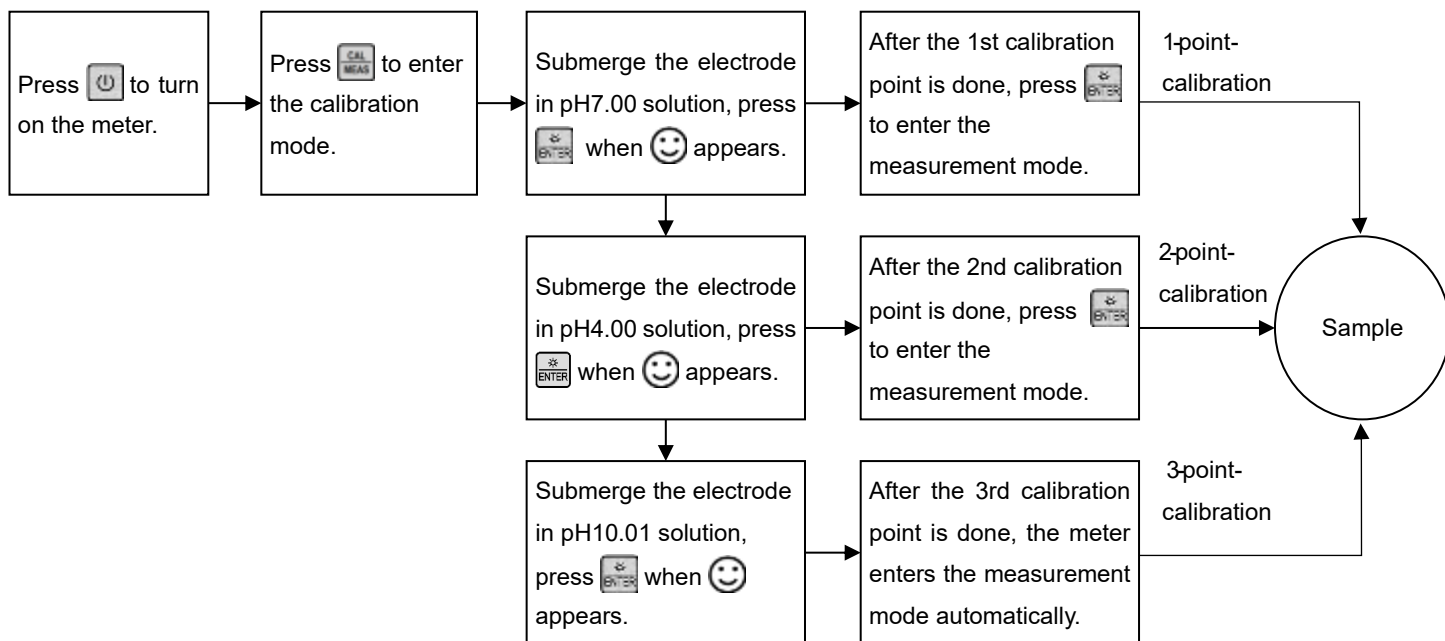

4.4.2 Self-Diagnosis Information

Table – 4 Self-diagnosis information

Display Icons	Contents	Checking
Er 1	Wrong pH buffer solution or the buffer solution out of range.	1.Check whether pH buffer solution is correct. 2.Check whether the meter connects the electrode properly. 3.Check whether the electrode is damaged.
Er 2	Press [ENTER] when measuring value is not stable during calibration.	Press [ENTER] key when ☺ icon appears and stays.
Er 3	During calibration, the measuring value being unstable for over 3 minutes	1.Check whether there are bubbles in glass bulb. 2.Replace with a new pH electrode.
Er 4	pH electrode zero electric potential out of range (<-60mV or >60mV)	1.Check whether there are bubbles in glass bulb. 2.Check whether pH buffer solution is correct. 3.Replace with new pH electrode.
Er 5	pH electrode slope out of range (<85% or >110%)	
Er 6	Enter in pre-set due calibration to remind calibration	Press [CAL] key to perform calibration or cancel due calibration setup in parameter P1.2.

4.4.3 pH isothermal measurement principle

According to the pH isothermal measurement principle, the closer the test sample's temperature is to the calibration solution's, the higher the accuracy of the measurement. So this principle is recommended to follow when conducting tests.

4.4.4 Restore to factory default

The instrument has a function to return to factory default setting, which can be set up in P1.5 (refer to section 7.3). Returning to factory default setting is to restore the meter to theoretical value (zero potential pH is 7.00, slope is 100%), and set all the parameters to default settings (see appendix 1). When the meter's calibration or measurement is performing abnormally, users can use this function to let the meter return to factory default mode, and then conduct calibration and test again. Please note that this function is irreversible once used.

4.5 Maintenance of the pH Electrode

4.5.1. Daily maintenance

The soaking solution contained in the supplied protective bottle is used to maintain activation in the glass bulb and junction. Loosen the capsule, remove the electrode and rinse in distilled or pure water before taking a measurement. Insert the electrode and tighten the capsule after measurements to prevent the solution from leaking. If the soaking solution is turbid or moldy, replace the KCL solution. (Preparation: 26g KCL dissolved in 100ml pure water).

The electrode should not be soaked in pure or distilled water, protein solution or acid fluoride solution for long periods of time. In addition, do not soak the electrode in organic lipids.

4.5.2. Calibration buffer solution

For calibration accuracy, the pH of the standard buffer solution must be reliable. The buffer solution should be refreshed often, especially after heavy use. We recommend 10-15 times of use before replacing the pH buffers.

4.5.3 Protect glass bulb

The sensitive glass bulb at the front of the combination electrode should not come in contact with hard surfaces. Scratches or cracks on the electrode will cause inaccurate readings. Before and after each measurement, the electrode should be washed with pure water and dried. If a sample sticks to the electrode or it's contaminated, the electrode should be thoroughly cleaned using a soft brush and then rinsed with pure water. After that, soak it in the KCL solution again for 6 hours.

4.5.4 Renew glass bulb

Electrodes that have been used over a long period of time will become aged. Submerge the electrode in 0.1mol/L hydrochloric acid for 24 hours, then wash the electrode in pure water, then submerge it in KCL soaking solution for 24 hours.

The method to prepare 0.1mol/L hydrochloric acid: dilute 9mL hydrochloric acid in pure water to 1000mL.

For serious passivation, submerge the bulb in 4% HF (hydrofluoric acid) for 3-5 seconds, and wash it in pure water, then submerge it in the soaking solution for 24 hours to renew it.

4.5.5. Clean contaminated glass bulb and junction (please refer to Table-8)

Table-8 Clean contaminated glass bulb and junction



Contamination	Cleaning Solutions
Inorganic metal oxide	Dilute acid less than 1mol/L
Organic lipid	Dilute detergent (weak alkaline)
Resin macromolecule	Dilute alcohol, acetone, ether
Proteinic haematocyte sediment	Acidic enzymatic solution (saccharated yeast tablets)
Paints	Dilute bleach, peroxide

Special Notes:

- 1) ***The 201T-S Plastic 3-in-1 Combination pH Electrode that comes with this meter will NOT give accurate and stable pH readings when testing distilled or deionized water. This is because these purified waters do not have enough ions present for the electrode to function properly. To measure purified water pH levels, users need to use a specialized electrode. Visit www.aperainst.de/electrodes and find the compatible Pure Water LabSen electrode for your meter in order to accurately test purified waters.***
- 2) ***The electrode housing is polycarbonate. When using cleaning solutions, take cautions on carbon tetrachloride, trichlorethylene, tetrahydrofuran, acetone, etc., which will dissolve the housing and invalidate the electrode.***

5 mV MEASUREMENT

5.1 ORP measurement

Press  key, and switch the meter to mV measurement mode. Connect ORP electrode (the 301Pt-S combination ORP electrode is sold separately) and dip it in sample solution, stir the solution briefly and allow it to stay in the solution until  icon appears and get the reading.

ORP means Oxidation Reduction Potential. The unit is mV.

5.2 Notes on ORP measurement

5.2.1 ORP measurement does not require calibration. When the user is not sure about ORP electrode quality or measuring value, use ORP standard solution to test mV value and see whether ORP electrode or meter works properly. Table-9 is the data of standard ORP solution for 222 mV.

Table-9

°C	10	15	20	25	30	35	38	40
mV	242	235	227	222	215	209	205	201

5.2.2 Clean and activate ORP electrode

After the electrode has been used over a long period of time, the platinum surface will get polluted which causes inaccurate measurement and slow response. Please refer to the following methods to clean and activate ORP electrode:

- (a) For inorganic pollutant, submerge the electrode in 0.1mol/L dilute hydrochloric acid for 30 minutes, then wash it in pure water, then submerge it in the soaking solution for 6 hours.
- (b) For organic or lipid pollutant, clean the platinum surface with detergent, then wash it in pure water, then submerge it in the soaking solution for 6 hours.
- (c) For heavily polluted platinum surface on which there is oxidation film, polish the platinum surface with toothpaste, then wash it in pure water, then submerge it in the soaking solution for 6 hours.

6 CONDUCTIVITY MEASUREMENT

6.1 Information regarding the Conductivity Electrode

6.1.1. Conductivity electrode

Model 2301T-S plastic conductivity electrode with constant $K=1.0$ and built-in temperature sensor, can realize automatic temperature compensation. The electrode housing is POM plastic which is corrosion resistant and impact resistant. When submerge the conductivity electrode in solution, stir the solution briefly to eliminate the air bubbles and improve response and stability.

6.1.2. Conductivity electrode constant

The meter matches conductivity electrodes of three constants: $K=0.1$, $K=1.0$ and $K=10.0$. Please refer to chart-6 for measuring range. Set constant in parameter setting P2.1 and refer to clause 7.4

Chart – 6 Electrode constant and measuring range

Range	$< 20 \mu\text{S/cm}$	$0.5 \mu\text{S/cm}$ to 100mS/cm			$> 100\text{mS/cm}$
Conductivity electrode constant	$K=0.1 \text{ cm}^{-1}$	$K=1.0 \text{ cm}^{-1}$			$K=10 \text{ cm}^{-1}$
Standard solution	$84 \mu\text{S/cm}$	$84 \mu\text{S/cm}$	$1413 \mu\text{S/cm}$	12.88mS/cm	111.8mS/cm
Electrode's model	DJS-0.1T-S	2301T-S			2310T-S

Note: When testing ultra-pure water with conductivity less than $1.0 \mu\text{S/cm}$, a flow test should be conducted in a flow cell.





6.1.3 When connecting the electrode, please rotate slowly to identify the location of the mount before plugging in. The nut on the connector should be screwed on tightly. Once the conductivity electrode is connected, the meter will automatically switch to conductivity mode (no need to switch manually). Please do not pull the cable in case of poor contact. Make sure the connector is clean and dry. See more information regarding the conductivity electrode's maintenance in section 6.6.

6.2 Information regarding Conductivity Calibration

6.2.1 Conductivity Standard Calibration Solutions

The meter uses conductivity standard solution of 84 $\mu\text{S/cm}$, 1413 $\mu\text{S/cm}$, 12.88 mS/cm and 111.8 mS/cm . The meter can recognize the standard solution automatically, and can perform 1 to 4 points of calibration. The calibration indication icons correspond to the four standard values as shown in Table-8.

Table-8 Conductivity Calibration Solutions

Calibration Icons	Calibration Solutions
	84 $\mu\text{S/cm}$
	1413 $\mu\text{S/cm}$
	12.88 mS/cm
	111.8 mS/cm

6.2.2 How often to calibrate

- (a) The meter has been calibrated before leaving the factory and can generally be used right out of the box.
- (b) Normally perform calibration once per month.
- (c) For high accuracy measurements or large temperature deviation from the reference temperature (25°C), perform calibration once per week.
- (d) Use conductivity standard solution to check whether there is error. Perform calibration if error is large.
- (e) For new electrode or the meter has been set to factory default, perform 3-point or 4-point calibration. For general use, choose standard solutions that are closer to the sample solution to perform 1-point or 2-point calibration.

6.2.3 Single point and multi-point calibration

If 1-point calibration is conducted after 3-point or 4-point calibration being done, the previous calibration values in the same range will be replaced. In the meanwhile, the meter will display the 1-point calibration's icon, and the other calibration icons will be removed, but the chip will still store the data from the last calibration. When conducting multi-point calibration, users should follow the sequence from low conductivity to high in case the high concentration solution contaminating the low ones.

6.2.4 Reference Temperature

The factory default setting for reference temperature is 25°C. The reference temperature can be set from 15°C to 30°C. Users can set it up in parameter setting P2.5 (see Section 7.4 for details).

6.2.5 Temperature compensation coefficient

The temperature compensation coefficient of the meter setting is 2.0%/°C. However, the conductivity temperature coefficient is different from solutions and concentration. Please refer to Table – 9 and the data collected during testing. Do the setting in P2.3. (see section 7.4 for more).

Note: When the coefficient for the temperature compensation is set to 0.00 (no compensation), the measurement value will be based on the current temperature.

Table – 9 Temperature compensation coefficient of special solutions

Solution	Temperature compensation coefficient
NaCl solution	2.12%/°C
5% NaOH solution	1.72%/°C
Dilute ammonia solution	1.88%/°C
10% hydrochloric acid solution	1.32%/°C
5% sulfuric acid solution	0.96%/°C

6.2.6 Precaution for calibration solution's contamination

Conductivity standard solution has no buffer. Please avoid being contaminated during usage. Before submerging the electrode in standard solution, please wash the electrode and allow it to dry. Please do not use the same cup of conductivity standard solution repeatedly, especially for standard solution of low concentration (84μS/cm). The contaminated standard solution will affect accuracy.

6.2.7 Calibration Reminder Setup

Preset the interval between calibrations (starting from the time when you set it), and then the meter will remind you to calibrate at the end of that interval. For details, please see P2.3 (Section 7.4). When the preset time is reached, **Er6** icon will be displayed at the lower right corner of the LCD (as showed in Figure-8). At the time, the meter can still be operated. It is just reminding you to do calibration in order to ensure the accuracy. After calibration, the **Er6** icon will disappear; To make it disappear, users can also choose "No" in P2.3 in parameter setting.

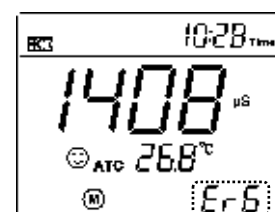

Figure-10

6.2.8 Check calibration date

In this mode, users can see the date and time of last calibration to help determine if there is a need to re-calibrate. For details, please see parameter setting P2.3 (Section 7.3)

6.3 Conductivity Calibration

1. Rinse the electrode in pure water, allow it to dry, wash with a little of standard solution and submerge it in standard solution. Stir the solution briefly and allow it to stay in the solution until a stable reading is reached.
2. Press **GAL** key to enter the calibration mode. The meter's display will show blinking "CAL" at the top right, and scanning and locking process of calibration solution at the bottom right. When the meter locks 1413 μS, stable icon ☺ will display on LCD. Press **ENTER** key to complete calibration. The meter will return to measuring mode and **M** is displayed on bottom left of the LCD screen. See Figure-11.



Figure-11

3. Notes:

(a) Pressing **ENTER** key before stable icon ☺ appeared on LCD screen, Error indication icon Er 2 will be shown. See Table -11.

(b) Press **MEAS** key before confirmation to exit calibration mode (calibration will not be completed).

- For multi-point calibrations, please repeat the steps in 6.3.1 to 6.3.2 until all calibrations are finished. The meter can be calibrated in the same calibration solution repeatedly until the reading is stable and repeatable.

6.4 TDS, Salinity, Resistivity & Conductivity

- TDS and conductivity is linear related. The conversion factor is 0.40-1.00. Adjust the factor from parameter P2.6. The factory default setting is 0.71 and please refer to section 7.4. Salinity and resistivity are all proportional to conductivity. The calculating formula is preset in the meter. So the meter only needs to be calibrated in Conductivity mode, then after calibration of conductivity, the meter can switch from conductivity to TDS, salinity, or resistivity.
- Adjust TDS conversion factor in parameter setting P2.6 according to the data collected during testing and experience. Table – 10 lists some commonly used Conductivity and TDS conversion factors. This is for your reference only.

Table – 10 Conductivity and TDS conversion factors

Conductivity of solution	TDS conversion factor
0-100 $\mu\text{S/cm}$	0.60
100-1,000 $\mu\text{S/cm}$	0.71
1-10 mS/cm	0.81
10-100 mS/cm	0.94

6.5 Sample test









- Rinse conductivity electrode in distilled or pure water, dry it, and submerge it in the sample solution. Stir the solution briefly and allow it to stay in the sample solution until a stable reading is reached and  icon appears on LCD, then get the reading value, which is the conductivity value of the solution.
- Press  key to switch to TDS, Salinity, and Resistivity.
- During the process of calibration and measurement, the meter has self-diagnosis functions, indicating the relative information as below: Table – 11.

Table – 11 Self-diagnosis information of conductivity measurement mode

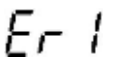
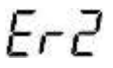
Display Icons	Contents	Checking
	Wrong conductivity calibration solution or the meter recognition of calibration solution out of range.	<ol style="list-style-type: none"> Check whether conductivity calibration solution is correct. Check whether the meter connects the electrode well. Check whether the electrode is damaged.
	Press  key when measuring value is not stable during calibration.	Press  key after  icon appears.
	During calibration, the measuring value being unstable for over 3 minutes.	<ol style="list-style-type: none"> Shake the electrode to eliminate bubbles in electrode head. Replace with new conductivity electrode.
	Enters pre-set due calibration to remind re-calibration	Press  key to perform calibration or cancel due calibration setup in parameter P2.3.

4. Factory default setting

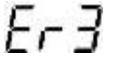
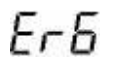
For factory default setting, please refer to parameter setting P2.7 (Section 7.4). With this function, all calibration data is deleted and the meter restores to the theory value. Some functions restore to the original value (refer to appendix -1). When calibration or measurement fails, please restore the meter to factory default setting and then perform re-calibration or measurement. Please note once set the factory default, all the data deleted will be irretrievable.



6.6 Maintenance of the Conductivity Electrode

6.6.1. Always keep the conductivity electrode clean. Before taking a measurement, rinse the electrode in pure water. It is recommended to rinse it again in the sample solution. When submerge the electrode in solution, stir the solution briefly to eliminate air bubbles and allow it to stay until a stable reading is reached. Conductivity electrodes are usually stored dry. For conductivity electrodes that haven't been used for a long time, users should soak the electrode in 12.88 mS calibration solution for 5-10 minutes, or to soak it in tap water for 1 to 2 hours. Rinse the electrode in pure water after measurement.

6.6.2. The sensing rod of Model 2301T-S conductivity electrode is coated with platinum black to minimize electrode polarization and expand measuring range. The platinum black coating adopted our special processing technology, which improves the electrode performance and the firmness of the coating. If the platinum black electrode is stained, gently clean the electrode with soft brush in warm water containing detergent or alcohol.

7 PARAMETER SETTING

7.1 Main Menu



In the measurement mode, press  key to enter in P1.0, then press  or  to switch main menu: P1.0→P2.0→P4.0. Please refer to Figure - 14.

P1.0: pH parameter setting menu,



P2.0: Conductivity parameter setting menu,

P4.0: Basic parameter setting menu.



7.2 Sub-Menu

7.2.1 In P1.0, press  to enter the submenu P1.1 for pH setting, press  and  to change submenu:

P1.1→P1.2→ ... →P1.5. See Figure-12 for details.

7.2.2 In P2.0, press  to enter the submenu P2.1 for conductivity setting, press  and  to change submenu:

P2.1→P2.2→ ... →P2.7. See Figure-12 for details.

7.2.4 In P4.0, press  to enter the submenu P4.1 for basic parameter setting, press  and  to change submenu: P4.1→P4.2→...→P4.8. See Figure-12 for details.

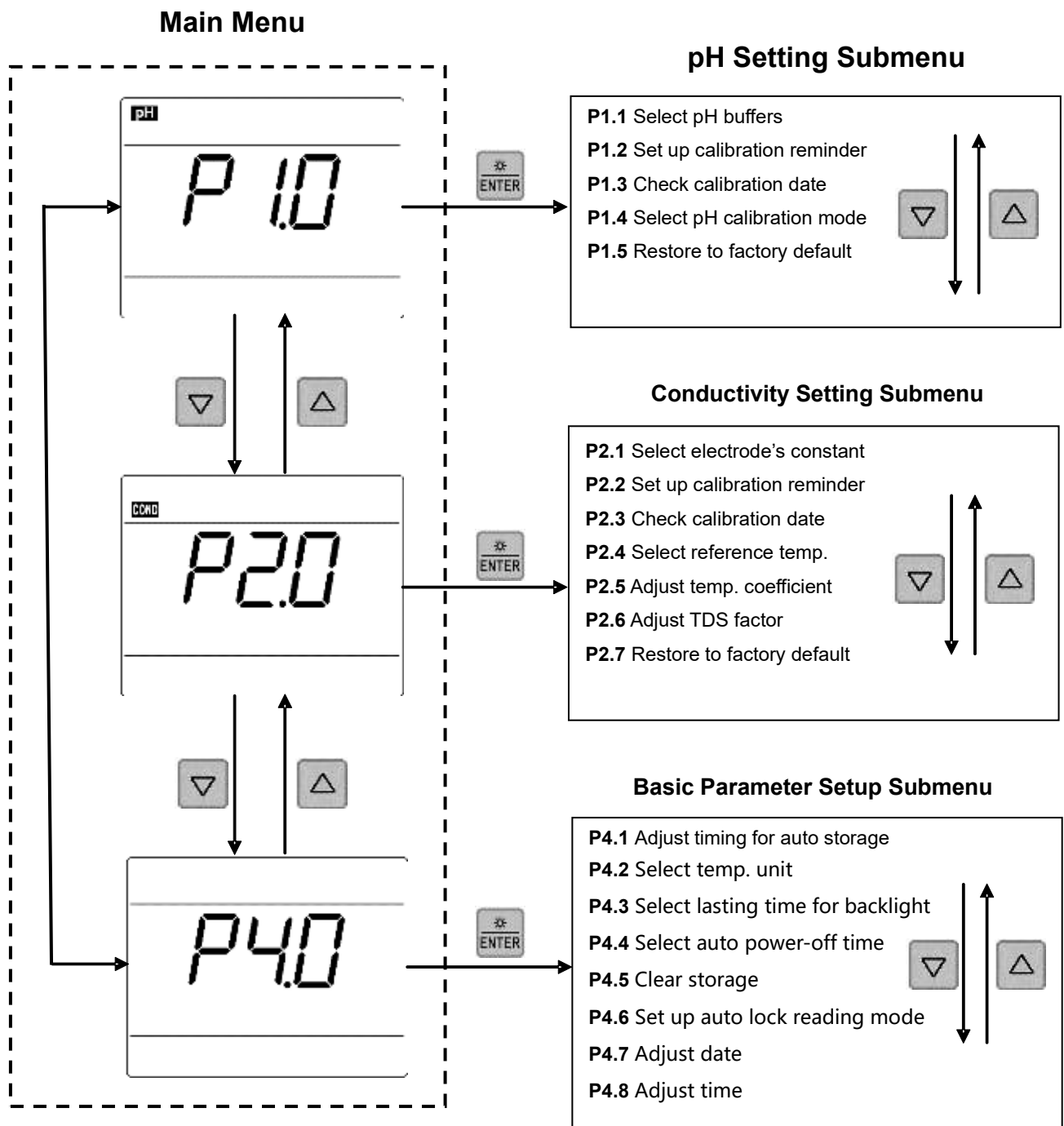
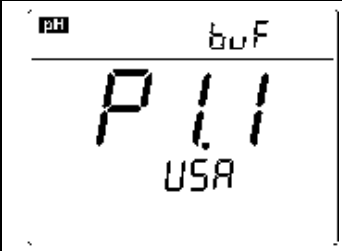







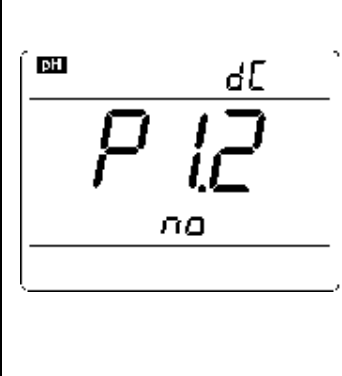











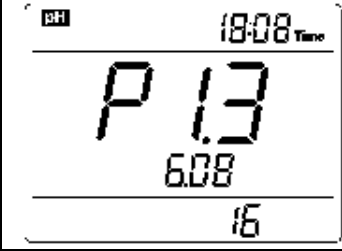

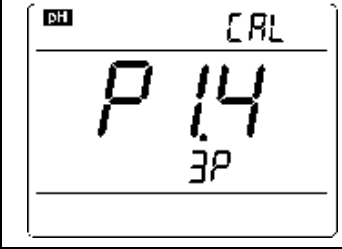





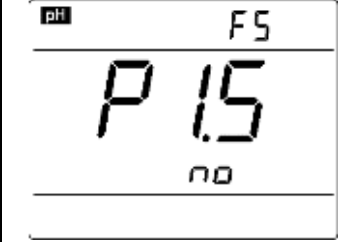



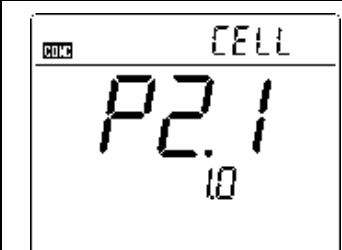







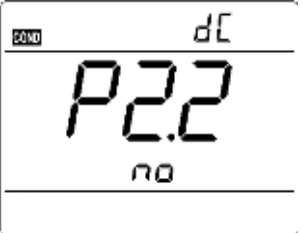











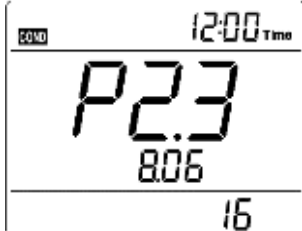























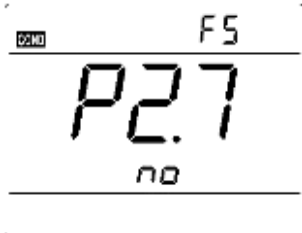



Figure-12

7.3 pH Setting Sub-Menu









	<p>P1.1 — Select pH buffer series (USA—NIST)</p> <ol style="list-style-type: none"> In measurement mode, long press  to enter P1.0, press  to enter P1.1 Press  USA flashes; Press  to choose USA→NIST; Press  to confirm. USA—USA NIS—NIST Press  to enter P1.2, or press  to return to measurement mode.
	<p>P1.2 — Set up calibration reminder (No—H00—D00)</p> <ol style="list-style-type: none"> Press , "No" flashes. Press  to choose No→H00→D00; NO—no setting; H00—set 0-99 hours; D00—set 0-99 days. When "H" flashes, press , "00" flashes; Press  to adjust hours, press  to confirm; when "D" flashes, press , "00" flashes, press  to adjust days, press  to confirm; When "No" flashes, press  to confirm. Press  to enter P1.3, or press  to return to measurement mode.
	<p>P1.3 — Check Calibration Time</p> <ol style="list-style-type: none"> The data and time of last calibration displayed on the left image is: 18:08, 06/08/2016 Press  to enter P1.4, or press  to return to measurement mode.
	<p>P1.4 — Select pH calibration mode (3P—5P)</p> <ol style="list-style-type: none"> Press , "3P" flashes. Press  to choose 3P→5P. Press  to confirm. 3P— 1 to 3 point calibration; 5P—1 to 5 point calibration. (see 4.2.2 for details) Press  to enter P1.5, or press  to return to measurement mode.
	<p>P1.5 — Return to factory default mode (No—Yes)</p> <p>Press , "No" flashes, press  to choose No→Yes; Press  to confirm, the meter returns to measurement mode.</p> <p>No— not return to factory default mode; Yes—return to factory default mode</p>

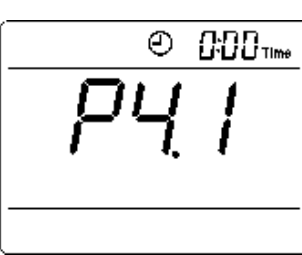















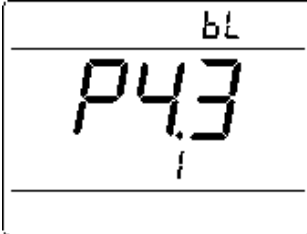





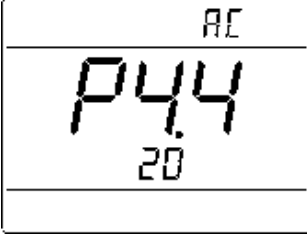





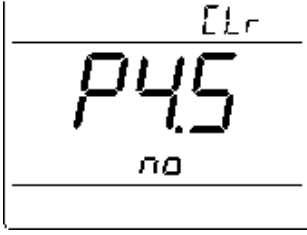





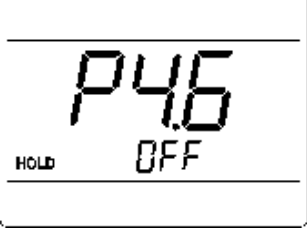





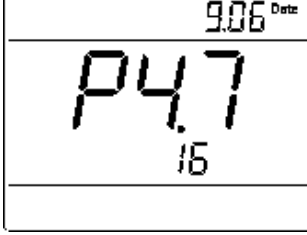

7.4 Conductivity Setting Sub-Menu

	<p>P2.1 — Select electrode's constant (1.0—10.0—0.1)</p> <ol style="list-style-type: none"> In P2.0, press  to enter P2.1 Press , "1.0" flashes, press  to choose 1.0→10.0→0.1; press  to confirm Press  to enter P2.2, or press  to return to measurement mode.
---	--

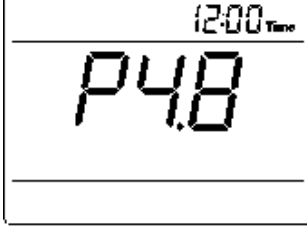
	<p>P2.2 — Set up calibration reminder (No—H00—D00)</p> <ol style="list-style-type: none"> Press , “No” flashes. Press  to choose No→H00→D00; NO—no setting; H00—set 0-99 hours; D00—set 0-99 days. When “H” flashes, press , “00” flashes; Press  to adjust hours, press  to confirm; when “D” flashes, press , “00” flashes, press  to adjust days, press  to confirm; When “No” flashes, press  to confirm. Press  to enter P2.3, or press  to return to measurement mode.
	<p>P2.3 — Check Calibration Time</p> <ol style="list-style-type: none"> The data and time of last calibration displayed on the left image is: 12:00, 08/06/2016 Press  to enter P2.4, or press  to return to measurement mode.
	<p>P2.4—Select reference temperature (25.0°C—18.0°C—20.0°C)</p> <ol style="list-style-type: none"> Press , “25.0°C” flashes, press  or  to adjust temp. from 15°C to 30°C; press  to confirm. Press  to enter P2.5, or press  to return to measurement mode.
	<p>P2.5—Adjust temp. compensation coefficient (0.00-9.99%)</p> <ol style="list-style-type: none"> Press , “2.00” flashes, press  or  to adjust from 0.00-9.99; press  to confirm. Press  to enter P2.6, or press  to return to measurement mode.
	<p>P2.6—Adjust TDS Factor (0.40-1.00)</p> <ol style="list-style-type: none"> Press , “0.71” flashes, press  or  to adjust from 0.40-1.00; press  to confirm. Press  to enter P2.7, or press  to return to measurement mode.
	<p>P2.7 — Return to factory default mode (No—Yes)</p> <p>Press , “No” flashes, press  to choose No→Yes; Press  to confirm, the meter returns to measurement mode.</p> <p>No— not return to factory default mode; Yes—return to factory default mode</p>

7.5 Basic Parameter Setting Sub-Menu

	<p>P4.1 — Adjust timing for auto storage</p> <ol style="list-style-type: none"> In P4.0, press  to enter P4.1 as shown in the left figure. Press , “:00” flashes, press  to set minute (0-59); press  again, “0:” flashes, press  to set hours (0-99), press  to confirm. Press  to enter P4.2, or press  to return to measurement mode.
---	--

	<p>P4.2 —(°C—°F)</p> <ol style="list-style-type: none"> 1. Press , “°C” flashes, press , “°F” flashes; when parameter flashes, press  to confirm. 2. Press  to enter P4.3, or press  to return to measurement mode.
	<p>P4.3—Select lasting time for backlight (1—2—3—On)</p> <ol style="list-style-type: none"> 1. Press , “1” flashes, press  to choose from 1→2→3→On; press  to confirm. Select On to have the backlight always turned on; time unit is minute. 2. Press  to enter P4.4, or press  to return to measurement mode.
	<p>P4.4 — Select auto power-off time (10—20—30—On)</p> <ol style="list-style-type: none"> 1. Press , “20” flashes, press  to choose from 20→30→On→10, press  to confirm. Select On to shut off the auto power-off function; time unit is minute. 2. Press  to enter P4.5, or press  to return to measurement mode.
	<p>P4.5 — Clear storage (No—Yes)</p> <ol style="list-style-type: none"> 1. Press , “No” flashes, press  to choose No→Yes; press  to confirm. No— not to clear data storage; Yes—clear all data storage 2. Press  to enter P4.6, or press  to return to measurement mode.
	<p>P4.6 — Set up Auto-Lock reading mode (Off—On)</p> <ol style="list-style-type: none"> 1. Press , “Off” flashes, press  to choose Off→On; press  to confirm. 2. Press  to enter P4.7, or press  to return to measurement mode.
	<p>P4.7 — Adjust Date</p> <ol style="list-style-type: none"> 1. Press  to choose “Month”→“Day”→“Year”, press  or  to adjust date, press to confirm. 2. Press  to enter P4.7, or press  to return to measurement mode.
	<p>P4.8 — Adjust time</p> <ol style="list-style-type: none"> 1. Press  to choose “Month”→“Day”→“Year”, press  or  to adjust date, press to confirm. 2. Press  to enter P4.7, or press  to return to measurement mode.

8 USB DATA COMMUNICATION

The instrument uses PC-Link software for data communication through USB connector and cable.

8.1 Software Interface

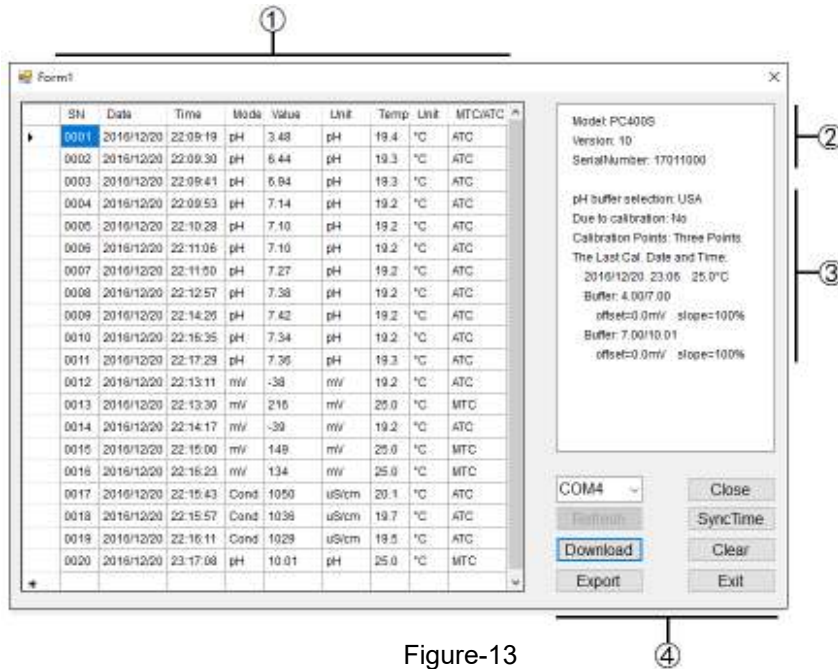



Figure-13

① — Stored data

(a) Press “Download” Key to upload the data in the meter to the software, including date, time, measurements, temperature, and temperature compensation mode. The program will categorize the data by pH, mV, and Cond.

(b) Press  after the meter is connected to the computer, or set up auto timing storage function. In this case, all the measuring data will be uploaded to the software, and will not be stored in the meter.

② — Model and Numberings

③ — Calibration information

④ — COM Port #and other buttons

COM Port # is the number for the software to connect with the computer. Every computer’s COM port is different. In Figure-13, the COM port # is COM4.

- Open/Close — Click it to turn on/off the program. When turned on, the LCD will display 
- Refresh — COM port reset button; Click it to reset the COM port to COM1.
- SyncTime — Click it to sync the computer’s time and date to the meter’s.
- Download — Click it to upload the data stored in the meter to the computer.
- Clear — Click it to clear all the data.
- Export — Click it to export all the data to a Microsoft Excel file.
- Exit — Click it to exit the program.

8.2 Install the software

The PC-Link software works for all Windows based system (does not work for Mac). Insert the PC-Link disk into the computer, open the PC-Link folder where you will find the folder for PC-Link software and a zipped file for drivers. Typically, users can directly open the file with PCLink icon to use the software. If the meter cannot be connected to

the computer, please install the USB driver (in the zipped file) before using the software.

8.3 Choose COM Port



Connect the meter to your computer with the USB cable. Open the PC-Link program. click the arrow icon next to the COM1 Port, and click the bottom port number, and then click Open. The LCD will display  icon. If port number is hard to be confirmed, users can identify it in Windows' Device Manager.

8.4 Run Software

8.4.1 Upload stored data

Click Download key to upload the data stored in the meter to the software, including date, time, measurements, temperature, and temperature compensation mode. The program will categorize the data by pH, mV, and Cond.

8.4.2 Real-time storage

- (a) When the program is running and meter is connected to computer, press  on the meter or set up auto timing storage to upload all the measuring data to the software. The data will not be stored in the meter in this mode.
- (b) The mode and unit for real-time storage is the same as it is in the meter. Press  or  to make changes.

8.4.3 Data Processing

Click "Export" to export all the data to a Microsoft Excel file. Users can process, analyze, and print the data in the Excel file.

9 COMPLETE KIT

	Content	Quantity	PH400S	EC400S	PC400S
1	PH400S Portable pH Meter	1	√		
2	EC400S Portable Conductivity Meter	1		√	
3	PC400S Portable pH/Conductivity Meter	1			√
4	201T-S Plastic 3-in-1 Combination pH Electrode	1	√		√
5	2301T-S Plastic Combination Conductivity Electrode	1		√	√
6	pH Standard Buffer (4.00 pH,7.00 pH,10.01pH)	50ml for each	√		√
7	Conductivity Standard Solution (84μS,1413μS,12.88mS)	50ml for each		√	√
8	PC-Link Software Disk	1	√	√	√
9	USB Cable	1	√	√	√
10	Small Carrying Case	1	√	√	
11	Big Carrying Case	1			√
12	Instruction Manual	1	√	√	√

10 WARRANTY

We warrant this instrument to be free from defects in material and workmanship and agree to repair or replace free of charge, at option of APERA INSTRUMENTS, any malfunctioned or damaged product attributable to responsibility of APERA INSTRUMENTS for a period of TWO YEARS (SIX MONTHS for the probe) from the delivery.

This limited warranty does not cover any damages due to:

Transportation, storage, improper use, failure to follow the product instructions or to perform any preventive maintenance, modifications, combination or use with any products, materials, processes, systems or other matter not provided or authorized in writing by us, unauthorized repair, normal wear and tear, or external causes such as accidents, abuse, or other actions or events beyond our reasonable control.

11 APPENDIX 1: TABLE OF PARAMETER SETTING AND FACTORY DEFAULT SETTING

Mode	Symbol	Parameter	Abbreviation	Content	Factory Default
P1.0 pH	P1.1	Select Buffer Series	buF	USA—NIST	—
	P1.2	Set calibration reminder	dc	No—H00—D00	No
	P1.3	Check calibration date and time	/	—	—
	P1.4	Select pH calibration mode	CAL	3P—5P	3P
	P1.5	Restore to factory default settings	FS	No—Yes	No
P2.0 Conductivity	P2.1	Select electrode's constant	CELL	1.0—10.0—0.1	1.0
	P2.2	Set calibration reminder	dc	No—H00—D00	No
	P2.3	Check calibration date and time	/	—	—
	P2.4	Select reference temperature	trEF	15°C - 30°C	25°C
	P2.5	Adjust temperature compensation coefficient	tCC	0.00 - 9.99	2.00
	P2.6	Adjust TDS factor	tDS	0.40 - 1.00	0.71
	P2.7	Restore to factory default setting	FS	No—Yes	No
P4.0 Basic Parameter	P4.1	Adjust timing for auto storage	/	—	—
	P4.2	Select temperature unit	/	°C - °F	—
	P4.3	Select lasting time for backlight	bl	1—2—3—On	—
	P4.4	Select time for auto power-off	RE	10—20—30—On	—
	P4.5	Clear data storage	CLr	No—Yes	—
	P4.6	Set up auto-lock reading mode	/	Off—On	—
	P4.7	Adjust date	/	—	—
	P4.8	Adjust time	/	—	—

12 APPENDIX 2: ICONS AND ABBREVIATION

Mode	Symbol	Abbreviation	Content
P1.0 pH	P1.1	bwF	Standard buffers
	P1.2	dC	Due Calibration
	P1.3	/	
	P1.4	CRl	Calibration mode
	P1.5	FS	Factory default setting
P2.0 Conductivity	P2.1	CELL	Cell
	P2.2	dC	Due Calibration
	P2.3	/	
	P2.4	tREF	Reference temperature
	P2.5	tCC	Temperature compensation coefficient
	P2.6	tDS	TDS Factor
	P2.7	FS	Factory default setting
P4.0 Basic Parameters	P4.1	/	
	P4.2	/	
	P4.3	BL	backlight
	P4.4	AC	Auto Close (power-off)
	P4.5	CLr	Clear data storage
	P4.6	/	
	P4.7	/	
Others		USA	USA Series
		n15	NIST Series
		OFF	Off
		On	On
		no	No
		YES	Yes

13 APPENDIX 3: TABLE OF SELF-DIAGNOSIS

Symbol	Self-Diagnosis Information	pH	Conductivity
Er 1	Wrong conductivity calibration solution or the meter recognition of calibration solution out of range.	√	√
Er 2	Press  key when measuring value is not stable during calibration.	√	√
Er 3	During calibration, the measuring value is not stable for ≥ 3 min.	√	√
Er 4	pH electrode zero electric potential out of range ($< -60\text{mV}$ or $> 60\text{mV}$)	√	
Er 5	pH electrode slope out of range ($< 85\%$ or $> 110\%$)	√	
Er 6	Enter in pre-set due calibration to remind re-calibration	√	√

APERA INSTRUMENTS (Europe) GmbH

Address: Wilhelm-Muthmann-Str.18

42329 Wuppertal, Germany

Email: info@aperainst.de

Website: www.aperainst.de

Tel.: +49 202 51988998